

SF|ZL strain relief plates

pluggable on 35 mm top hat rails

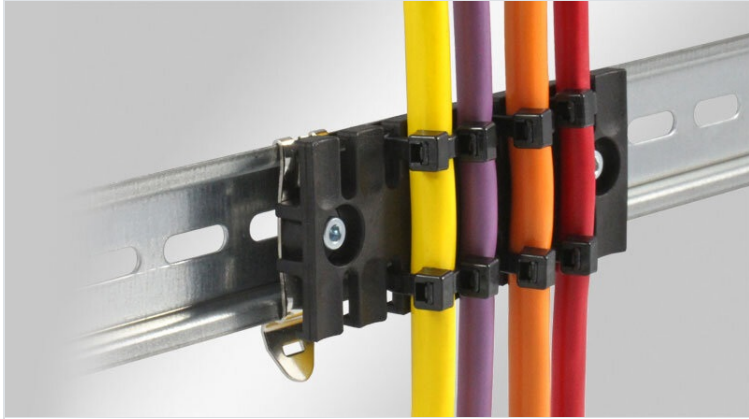

The strain relief plate SF|ZL is used for assembly on 35 mm top hat DIN rails. It can be used for strain relief of cables and conduits.

The SF|ZL range is based upon the [strain relief plate ZL](#), which is mounted on snap-in mounting feet for 35 mm top hat rails.



Specifications

Material	Polyamide Snap foot: Spring steel
Flame class	UL94-V0, self-extinguishing
Operating temperature	-40 C° to 140 C°
Properties	silicone free, halogen free
Mounting options	Snap-in

Advantages & benefits

- Strain relief according to EN 62444
- Fast and easy mounting
- Cost-effective solution
- High cable density
- Versatile utilisation

Product types & sizes

SF|ZL 39

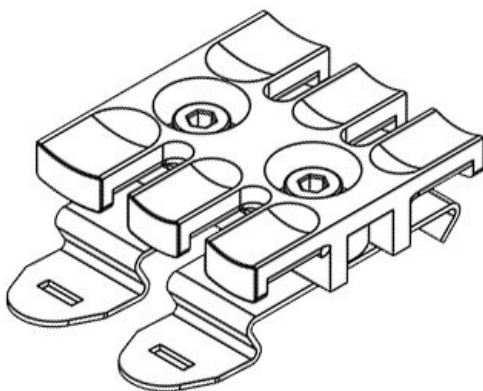

Part No.	32351	Mounting height	11,4 mm
EAN	4251269301	No. of teeth	3
Package quantity	10		
For max. no. of cables	3		
Length	38,5 mm		
Width	51,7 mm		
Height	16 mm		

SF|ZL 60

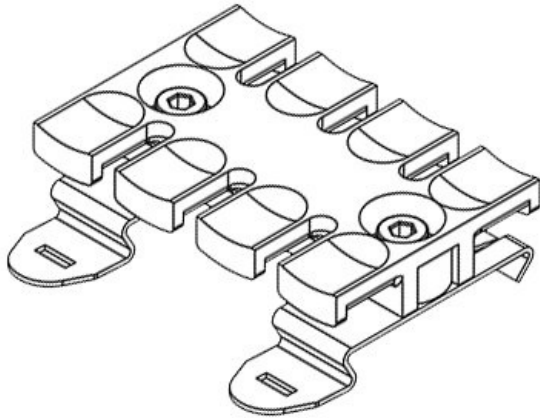

Part No.	32352	Mounting height	11,4 mm
EAN	4251269301	No. of teeth	4
Package quantity	10		
For max. no. of cables	4		
Length	59,5 mm		
Width	51,7 mm		
Height	16 mm		

SF|ZL 70

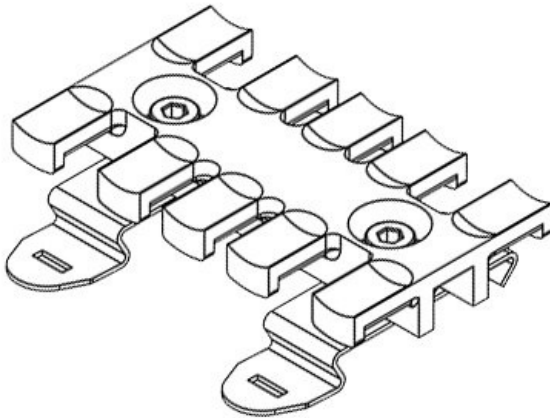

Part No.	32353	Mounting height	11,4 mm
EAN	4251269301	No. of teeth	5
Package quantity	10		
For max. no. of cables	5		
Length	69,1 mm		
Width	51,7 mm		
Height	16 mm		

SF|ZL 87

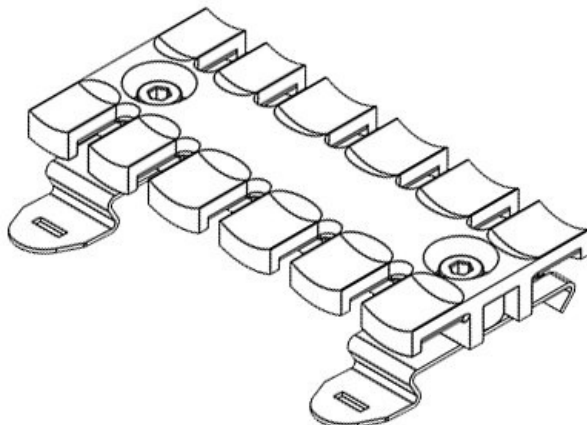

Part No.	32354	Mounting height	11,4 mm
EAN	4251269301	No. of teeth	6
Package quantity	10		
For max. no. of cables	6		
Length	86,5 mm		
Width	51,7 mm		
Height	16 mm		

SF|ZL 103

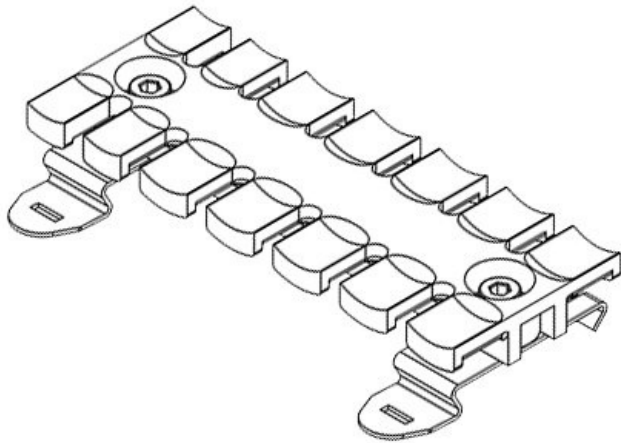

Part No.	32355	Mounting height	11,4 mm
EAN	4251269301	No. of teeth	7
Package quantity	285		
For max. no. of cables	10		
Length	102,5 mm		
Width	51,7 mm		
Height	16 mm		

SF|ZL 121

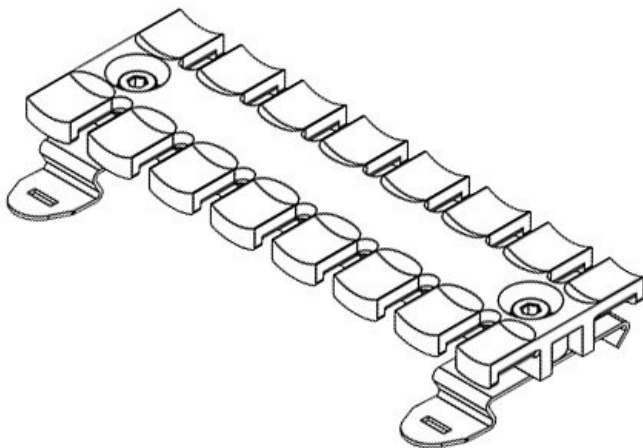

Part No.	32356	Mounting height	11,4 mm
EAN	4251269301	No. of teeth	8
Package quantity	292		
For max. no. of cables	10		
Length	121 mm		
Width	51,7 mm		
Height	16 mm		

SF|ZL 140

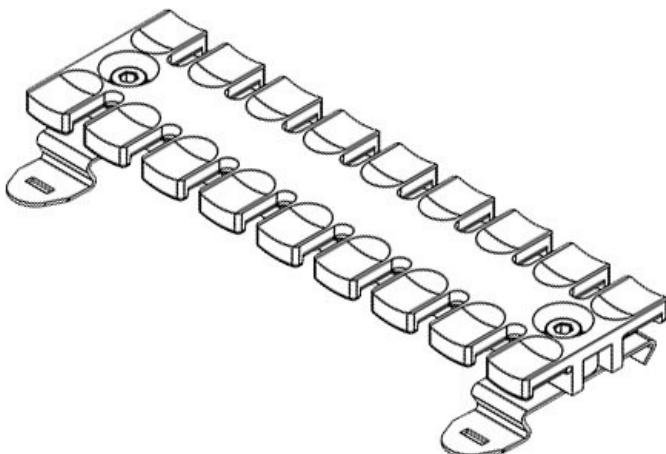

Part No.	32357	Mounting height	11,4 mm
EAN	4251269301	No. of teeth	9
Package quantity	308		
For max. no. of cables	10		
Length	139,5 mm		
Width	51,7 mm		
Height	16 mm		

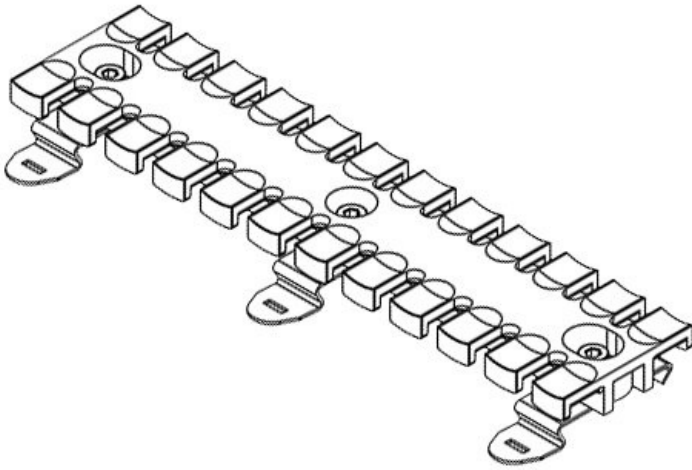

Part No.	32358	Mounting height	11,4 mm
EAN	4251269301	No. of teeth	12
Package quantity	10		
For max. no. of cables	12		
Length	180 mm		
Width	51,7 mm		
Height	16 mm		